



Y. LIN ELECTRONICS CO., LTD.

Data Sheet

Customer: _____
Part No: _____ YL4.8BDST16K24S40-C _____
Sample No: _____
Description: _____ 4.8mm Photodiode _____
Item No: _____

Customer			
Check	Inspection	Approval	Date

Y.LIN			
Drawn	Check	Approval	Date
			2014-8-20

TEL:0769-87181888 FAX:0769-87187333

E-mail:ylin06@y-lin.com Http://www.yong-lin.net

Mainland address:Jinhe the third Industrial Zone,Zhangmutou Town

Dongguan Guangdong China

H.K address:Unit 503 5/F,Silvercord Tower 230 Canton Road Tsimshatsui



YL4.8BDST16K24S40-C

Features:

- . Mechanically and spectrally matched to the phototransistor.
- . Rohs compliant.



Description

- . This devices are made with PIN GaAs.

Package Dimensions:

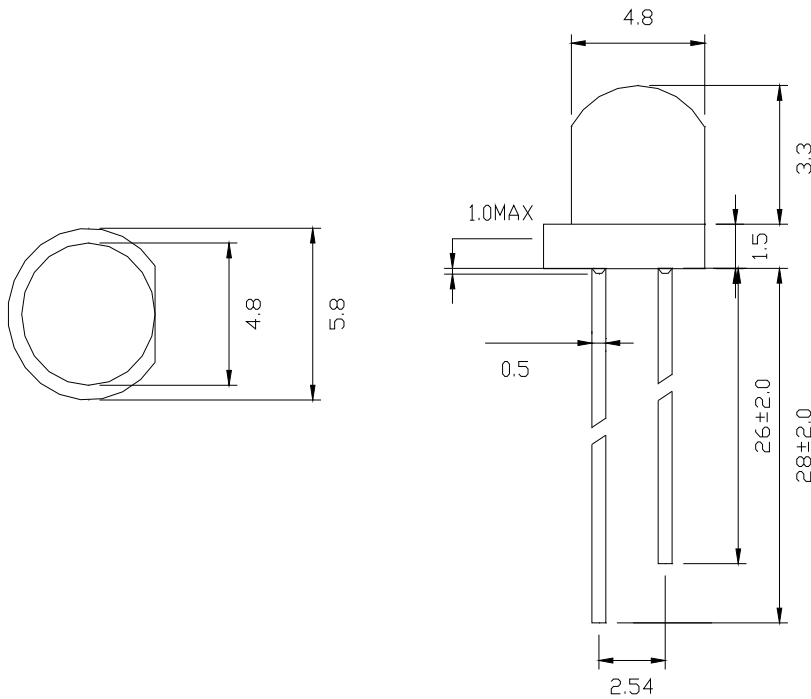

NOTES

- 1.All dimensions are in millimeters .
- 2.Tolerance is $\pm 0.25\text{mm}$ unless otherwise noted.



Part No	Material				Lens Color	
PD	Silicon				Black	
Parameter	Symbol	Min.	Typ.	Max	Unit	Test Condition
Forward Voltage	V_F			1.2	V	$E_e=0\text{mW/cm}^2$ $I_F=10\text{mA}$
Reverse Dark Current	I_D			10	nA	$E_e=0\text{mW/cm}^2$ $V_R=10\text{V}$
Controlled Angle	2 θ 1/2		120		deg	



Electrical / Optical Characteristics at Ta=25°C

Parameter	Symbol	Min.	Typ.	Max	Units	test conditions
Rang of Spectral Bandwidth	$\lambda_{0.5}$	800		1200	nm	$V_s=5v$ $E_v=0$
Peak Wavelength	λ_p		940		nm	
Open-Circuit Voltage	V_{OC}		300		mV	$E_e=5mW/cm^2$ $T=2856K$
Short Circuit current	I_{SC}		6		μA	$E_e=5mW/cm^2$ $T=2856K$
Reverse Breakdown Voltage	V_{BR}	35			V	$E_e=0mW/cm^2$ $I_R=100\mu A$
Total Capacitance	C_t		4		pF	$E_e=0mW/cm^2$ $V_R=5V$ $f=1MHz$
Reverse Light Current	I_L		6		μA	$E_e=5mW/cm^2$ $T=2856K$ $V_R=5V$

Note:

1. 1/2 is the angle from optical centerline where the luminous intensity is 1/2 the optical centerline value.

2. the above luminous intensity measurement allowance tolerance $\pm 15\%$

Absolute Maximum Ratings at Ta=25°C

Parameter	Symbol	Rating	Units
Collector-Emitter Voltage	V_{ce0}	30	V
Emitter-Collector Voltage	V_{eco}	5	V
Collector Current	IC	20	mA
Power Dissipation	PD	75	mW
Operating Temperature	T_{opr}	-20~+80	°C
Storage Temperature	T_{stg}	-40~+100	°C
Lead Soldering Temperature [1.6mm(.063") From Body]		260°C for 5 seconds	

Note:

1. 1/10 Dut cycle, 0.1ms pulse width.

2. The above forward voltage measurement allowance tolerance $\pm 0.1V$.



Typical optical characteristics curves

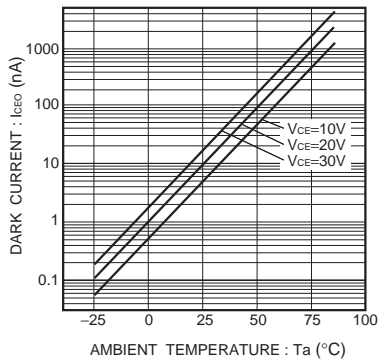

Fig.1 Dark current vs. ambient temperature

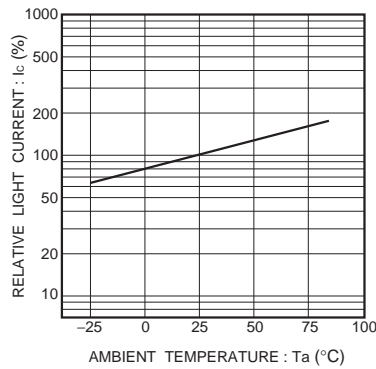

Fig.2 Relative output vs. ambient temperature

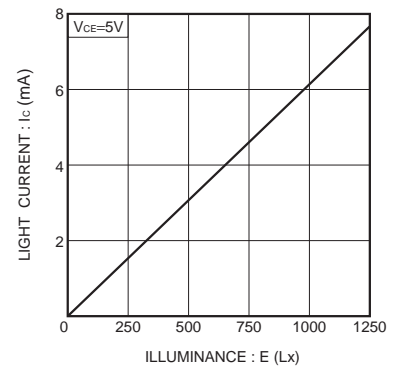

Fig.3 Light current vs. irradiance

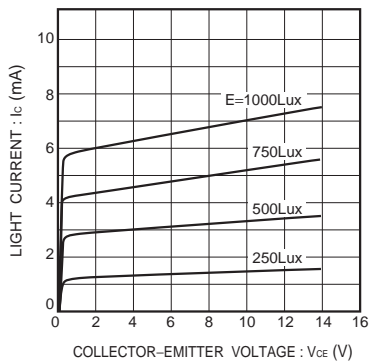

Fig.4 Output characteristics

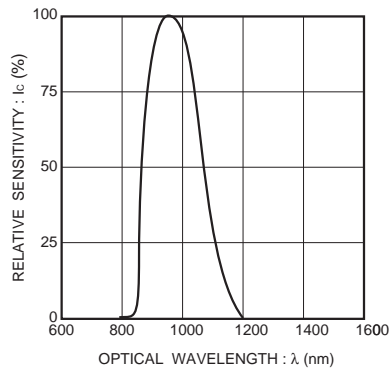

Fig.5 Spectral sensitivity

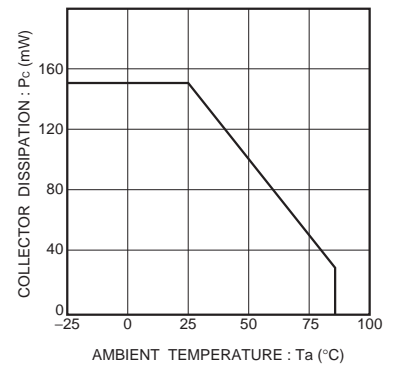

Fig.6 Collector dissipation vs. ambient temperature

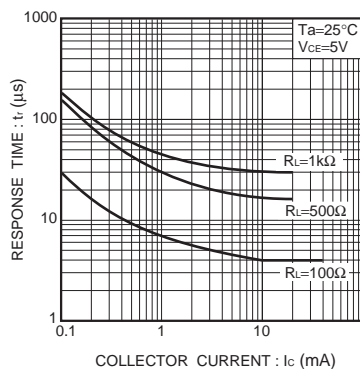
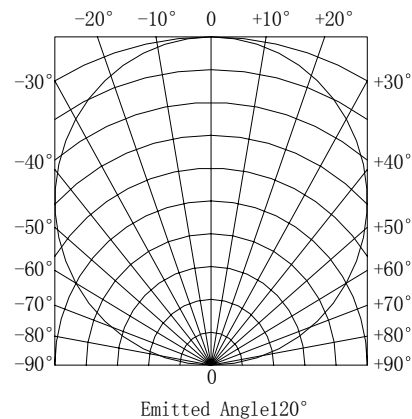

Fig.7 Response time vs. collector current





1.Application:

Infrared applied system
Camera
Printer
Optoelectronic switch
Cockroach catcher

2. Cleaning

Use alcohol-based cleaning solvent such as isopropyl alcohol to clean the LEDs if necessary.

3.Soldering

When soldering leave a minimum of 2mm clearance from the base of the lens to the soldering point.

Dipping the lens into the solder must be avoided.

Do not apply any external stress to the lead frame during soldering while the LED is at high temperature.

Recommended soldering conditions:

Soldering iron		Wave soldering	
Temperature	320°C Max	Pre-heat Pre-heat time	100°C Max 60 sec.Max
Soldering time	3 sec.Max (one time only)	Solder wave Soldering time	260°C Max 5 sec.Max

Note: Excessive soldering temperature and/or time might result in deformation of the LED lens or catastrophic failure of the LED.

4.Lead Forming & Assembly

During lead forming, the leads should be bent at point at least 3mm from the base of PIN lens.

Do not use the base of the lead frame as a fulcrum during forming.

Lead forming must be done before soldering, at normal temperature.

During assembly on PCB, use minimum clinch force possible to avoid excessive mechanical stress.

5.Protece Of ESD

Since the device is static sensitive, it is requested that anti-static measures should be taken on human body, all devices (including soldering iron) and equipment, machinery, desk and ground.